

1
2
3
4
5
6
7
8
9
10
11
12
13
14
15
16
17
18
19
20
21
22
23
24
25
26

UNITED STATES DISTRICT COURT
WESTERN DISTRICT OF WASHINGTON

DOGGYPHONE LLC,

Plaintiff,

v.

TOMOFUN, LLC,

Defendant.

Civil Action No. 19-cv-1901

COMPLAINT FOR PATENT
INFRINGEMENT

DEMAND FOR JURY TRIAL

Plaintiff Doggyphone LLC alleges the following causes of action against Defendant Tomofun, LLC:

I. PARTIES

A. PLAINTIFF

1. Plaintiff Doggyphone LLC (“Doggyphone”) is a Washington limited liability company having a registered address in Bellevue, Washington.

B. DEFENDANT

2. Tomofun, LLC (“Tomofun”) is believed to be a California limited liability company with company headquarters located at 3209 134th Ave NE, Bellevue, WA 98005. Tomofun’s corporate registered agent is United States Corporation Agents Inc. having a street address of 3209 134th Ave NE, Bellevue, WA 98005.



II. JURISDICTION AND VENUE

1
2
3
4
5
6
7
8
9
10
11
12
13
14
15
16
17
18
19
20
21
22
23
24
25
26

3. This action arises under the patent laws of the United States, including 35 U.S.C. §§ 271 and 281. Accordingly, original jurisdiction is conferred upon this Court pursuant to 28 U.S.C. §§ 1331.

4. Venue and personal jurisdiction are proper in this Court pursuant to 28 U.S.C. §§ 1391 and/or 1400(b).

5. This Court has personal jurisdiction over Tomofun because Tomofun has: (a) offered, sold, advertised and provided within retail stores in this District infringing products; (b) resides in, maintains and has maintained continuous and systematic contacts with this District over a period of time through at least such activities; and (c) purposefully availed itself of the benefits of doing business in this District. Accordingly, Tomofun maintains minimum contacts with this District that are more than sufficient to subject the Tomofun to service of process in compliance with due process of law.

6. Venue is proper because, at all times relevant hereto, Tomofun resides or is otherwise found in this District and a substantial part of the events giving rise to Doggyphone’s claims occurred in this District, including but not limited to Tomofun’s transacting business and engaging in acts of patent infringement in this District. Tomofun is subject to personal jurisdiction in this District at the commencement of this action, as set forth above.

III. DOGGYPHONE’S PATENT RIGHTS

7. Doggyphone is the assignee of U.S. Patent No. 9723813 entitled “Internet Canine Communication Device and Method,” which issued August 8, 2017 to Andrew Peter Davis (“the 813 patent”). A true and accurate copy of the 813 patent is attached as Exhibit A. Doggyphone owns the full right, title and interest in the 813 patent, including the right to sue for past and present infringement.

8. The claims of the 813 patent cover, *inter alia*, an enhanced system and method for human-pet communication. More specifically, it facilitates remote communication and interaction

1 between a dog and its owner, caretaker, trainer, family member, or the like. The system may be
2 configured to deliver treats to a pet and to transmit audio/visual communication between the pet
3 and a remote client device operated by a human user.

4 9. Exemplary images from the 813 patent are shown below, illustrating an internet
5 canine communication device:

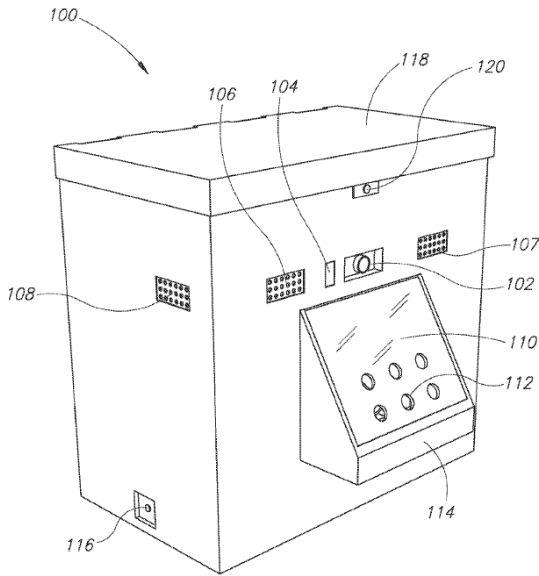

FIG.1

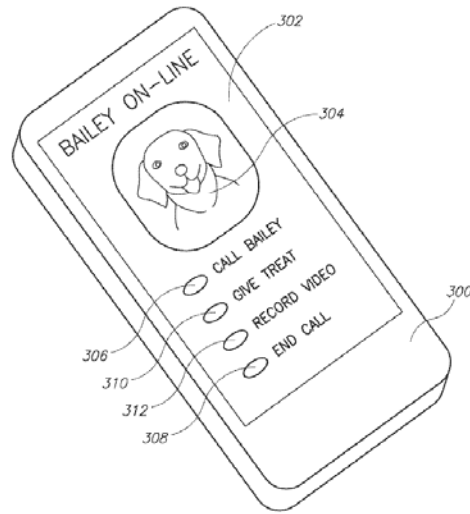

FIG.8

17 **IV. TOMOFUN'S PATENT INFRINGEMENT**

18 10. Tomofun has made, imported, offered for sale, and/or sold an interactive pet camera
19 under at least the brand name FURBO, an image of which is shown below:









IV. CAUSE OF ACTION—INFRINGEMENT OF THE 813 PATENT

11. Doggyphone repeats the allegations above.

12. The interactive pet camera made, offered for sale, sold, and imported by Tomofun, including without limitation those sold under the FURBO brand name, infringe Doggyphone’s 813 patent. Without limitation, the infringed claims include at least claim 7.

13. By way of example, below is a summary chart showing how each limitation of claim 7 reads on features of at least Tomofun’s FURBO interactive pet camera:

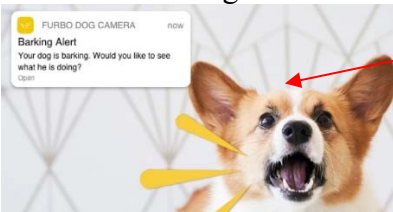
813 Patent	FURBO
<p>7. A system for communicating with a pet, comprising:</p>	 <p>“Furbo is the only pet camera with treat dispenser designed just for dogs. The dog treat camera lets you see, talk, and toss treats to your dog when you’re not home.” (http://shopus.furbo.com)</p>
<p>a treat bin;</p> <p>a food dispenser that dispenses treats from the treat bin;</p> <p>an audio device;</p>	 <p>Treat bin accessible under cover</p> <p>Audio device</p> <p>Food dispenser</p>
<p>a delivery module that:</p> <p>receives a treat delivery command; and</p> <p>in response to the received treat delivery command:</p> <p>dispenses via the food dispenser at least one treat from the treat bin;</p> <p>plays via the audio device an audio signal that notifies the pet of availability of a treat; and</p> <p>receives input from the pet; and</p>	 <p>The Furbo receives treat delivery command from mobile app.</p> <p>In response, the Furbo tosses a treat via the dispenser.</p> <p>The Furbo plays a chime when tossing a treat: “Similar to the clicker training, Furbo makes a “clicking” sound before tossing a treat.” (https://shopus.furbo.com/pages/designed-for-dogs)</p> <p>The Furbo receives input from the pet via the microphone, video camera, and/or barking sensor.</p>

813 Patent	FURBO
<p>1 <i>a control that transmits to the</i> 2 <i>delivery module a treat delivery</i> 3 <i>command,</i></p>	 <p>A mobile app is used to transmit a delivery command (“Treat Toss” button) to the delivery module</p>
<p>5 <i>wherein the system:</i> 6 <i>in response to a first</i> 7 <i>communication command</i> 8 <i>received from a user,</i> 9 <i>transmits to the delivery</i> 10 <i>module the treat delivery</i> 11 <i>command;</i></p>	<p>When the Furbo receives a delivery command (initiated via the “Treat Toss” button on the mobile app), the Furbo tosses a treat.</p>
<p>12 <i>plays at least one of live audio</i> 13 <i>or video received from the</i> 14 <i>user of a remote client</i> 15 <i>device; and</i></p>	<p>The mobile app has a 2-Way talk feature, which transmits audio from the app to the Furbo, which plays the audio via its speaker.</p>
<p>16 <i>transmits to the remote client</i> 17 <i>device at least one of live</i> 18 <i>audio or video of the pet,</i> 19 <i>wherein the system begins</i> 20 <i>transmission to the remote</i> 21 <i>client device of at least one of</i> 22 <i>the audio or video of the pet in</i> 23 <i>response to input from the pet.</i></p>	<p>The Furbo transmits video to the mobile app for display, as shown above. The Furbo begins transmission in response to input from the pet, at least via the Real-time Barking Alert feature or the Furbo Dog Nanny feature.</p> <p>Real-time Barking Alert:</p>  <p>In response to detected barking, the Furbo transmits live</p> <p>Dog Nanny (Real-time Smart Alerts):</p>  <p>In response to detected activity, the Furbo transmits live video</p>

24 14. Tomofun has not been granted any license or other authority from Doggyphone to
 25 make, import, use, offer for sale, or sell its interactive pet camera.
 26

1 15. The activities by Tomofun with regard to its interactive pet camera constitute direct,
2 indirect and/or contributory infringement of the 813 patent pursuant to 35 U.S.C. § 271.

3 16. As a direct result of the infringing activity by Tomofun, Doggyphone has suffered,
4 and will continue to suffer, damages in an amount to be established at trial. In addition,
5 Doggyphone has suffered, and continues to suffer, irreparable harm for which there is no adequate
6 remedy at law.

7 17. The infringement by Tomofun has been and continues to be with full knowledge of
8 the 813 patent and Doggyphone’s patent infringement claims. Tomofun has ignored
9 Doggyphone’s November 1, 2019 notice letter. Tomofun’s infringement is in willful disregard of
10 Doggyphone’s patent rights.

11 **V. PRAYER FOR RELIEF**

12 Doggyphone requests the following alternative and cumulative relief:

- 13 a. That Tomofun be preliminarily and permanently enjoined and restrained from
14 directly or indirectly making, using, importing, exporting, offering for sale, or
15 selling an interactive pet camera that infringes Doggyphone’s patent claims;
- 16 b. That Tomofun pay damages adequate to compensate Doggyphone for the
17 infringement by the Tomofun, and in no event less than a reasonable royalty for the
18 use of the invention;
- 19 c. That the damages award be trebled pursuant to 35 U.S.C. § 284;
- 20 d. That Doggyphone be granted its reasonable attorney’s fees pursuant to
21 35 U.S.C. § 285 or other applicable laws;
- 22 e. That Doggyphone be awarded prejudgment interest, post-judgment interest, and
23 costs; and
- 24 f. Such other and further relief as the Court may deem just and proper.

1
2
3
4
5
6
7
8
9
10
11
12
13
14
15
16
17
18
19
20
21
22
23
24
25
26

RESPECTFULLY SUBMITTED November 22, 2019.

s/ David A. Lowe, WSBA No. 24,453

Lowe@LoweGrahamJones.com

LOWE GRAHAM JONES^{PLLC}

701 Fifth Avenue, Suite 4800

Seattle, Washington 98104

T: 206.381.3300

Attorneys for Doggyphone, LLC

